

**Missile Tank / APC  
15mm Model**  
Available Free from  
Germ's World  
[www.germy.co.uk](http://www.germy.co.uk)

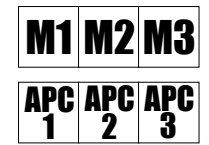

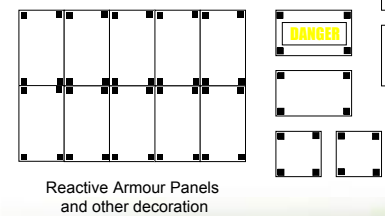

Light Hover Skirt

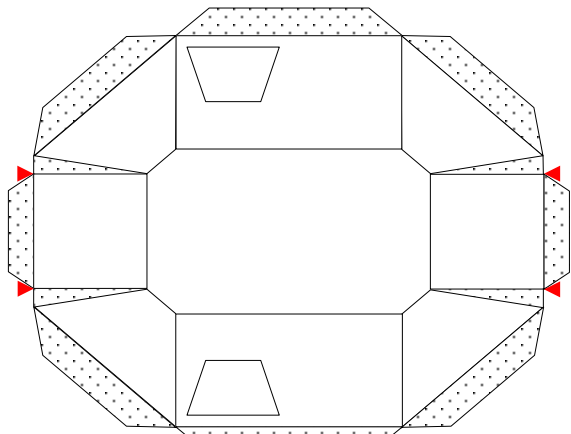
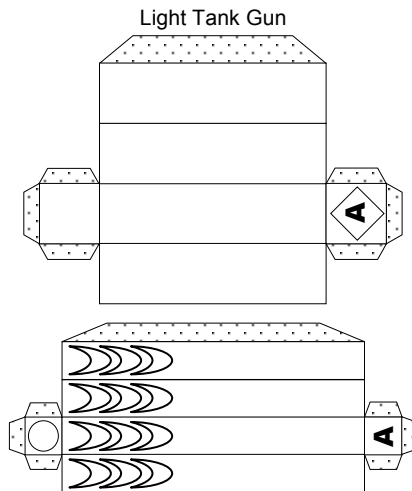

Light Tank Gun

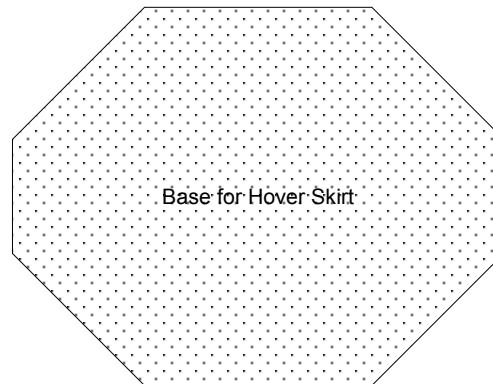

Base for Hover Skirt

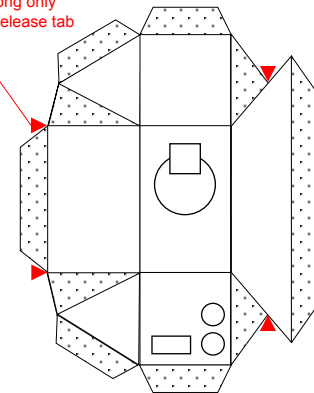

Light Tank Turret

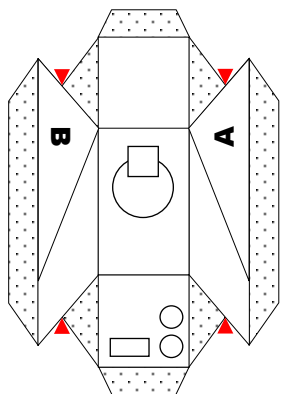

AA Gun Turret

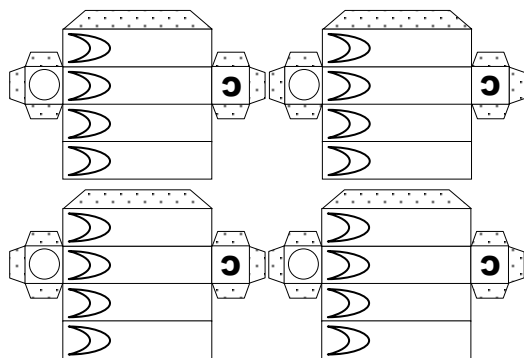

AA Guns

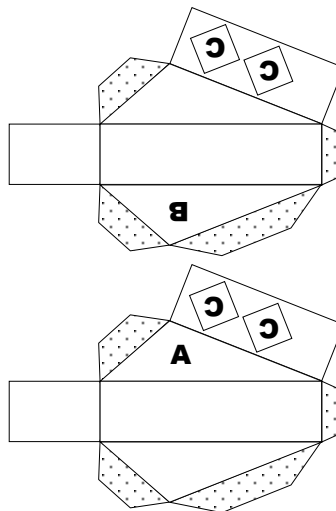

AA Turret alternative  
For use with Hover Skirt

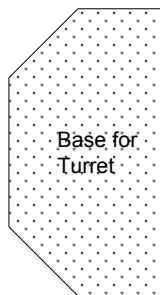

Base for  
Turret

**Missile Tube  
Alternative gun mount**

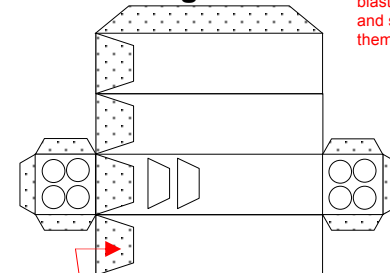

Fold these two parts of each blast fin over and stick them together

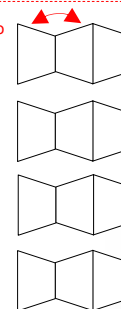

Once missile tube is built stick blast fins onto these points

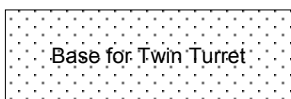

Base for Twin Turret

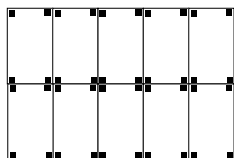

Reactive Armour Panels  
and other decoration

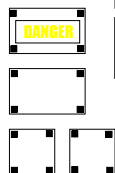

**Light Tank  
with Gun / Missile / AA  
turret options  
15mm Model  
Available Free from  
Germ's World  
www.germy.co.uk**



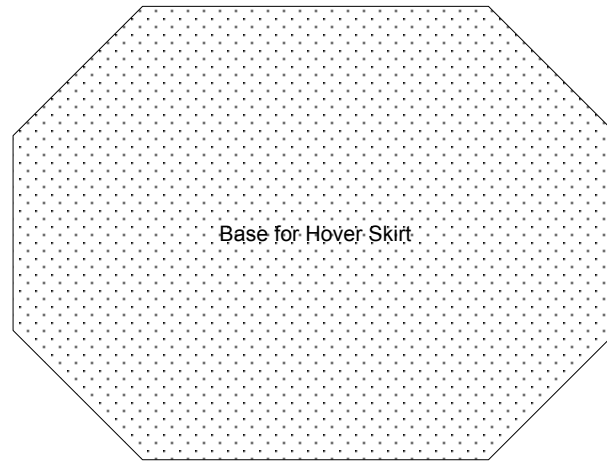
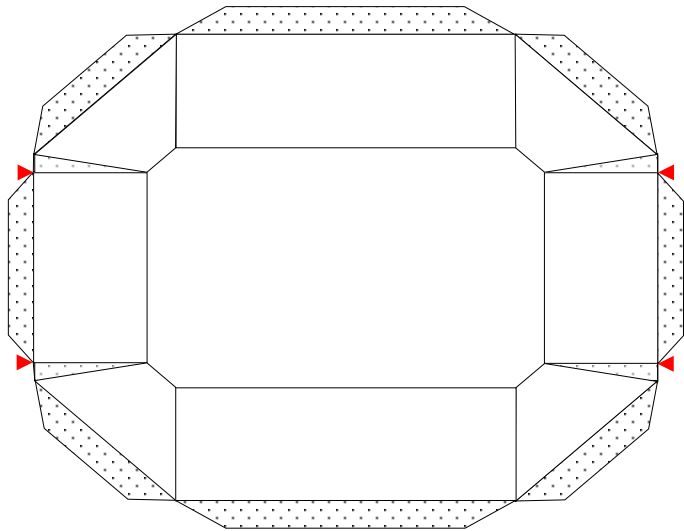

Base for Hover Skirt

After cutting out parts and scoring along all black lines cut along only the black lines marked to release tab

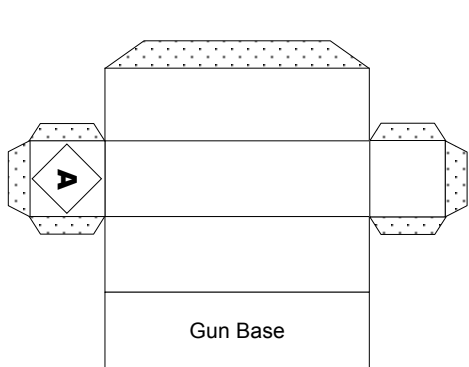
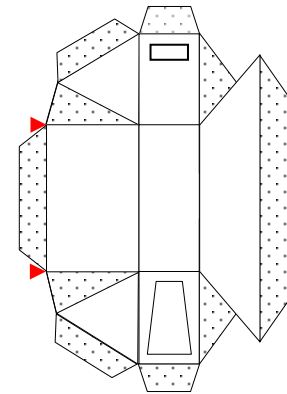
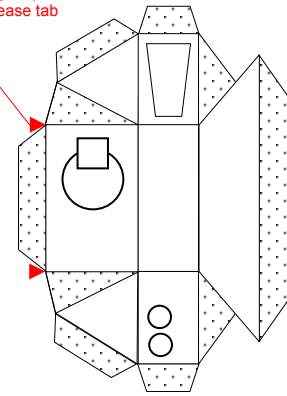

Gun Base

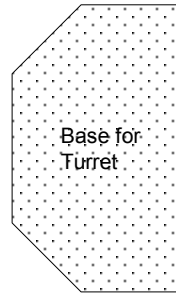

Base for Turret

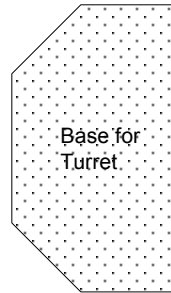

Base for Turret

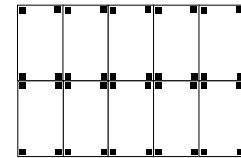
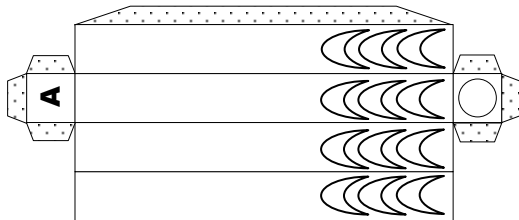

Reactive Armour Panels and other decoration

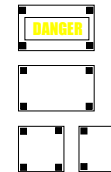

<b>T1</b>	<b>T2</b>	<b>T3</b>
<b>T4</b>	<b>T5</b>	<b>T6</b>

**Heavy Tank  
15mm Model**  
Available Free from  
Germ's World  
[www.germy.co.uk](http://www.germy.co.uk)

